



**DOWNLIGHTLED**

**ecoreva**  
maîtriser le futur

➤ **CARACTERISTIQUES TECHNIQUES - TECHNICALS SPECIFICATIONS**



Tension d'entrée - <i>Input voltage</i>	220-240 VAC
Courant d'appel - <i>Starting current</i>	36 – 90 mA
Angle d'éclairage - <i>Viewing Angle</i>	180°
Cosinus PHI - <i>Power Factor</i>	>0,95
Indice de protection - <i>Protection factor.</i>	IP44

Référence <i>Referenc e</i>	Série - <i>Serie</i>	DWL	DWL	DWL	DWL
	diamètre - <i>Diameter</i>	120	150	180	230
	Couleur - <i>Color</i>	840	840	840	840
	Puissance - <i>Power</i>	08	16	19	23
Diffuseur <i>Diffuser</i>		Givré - <i>Frosted</i>	Givré - <i>Frosted</i>	Givré - <i>Frosted</i>	Givré - <i>Frosted</i>
Type de LED <i>Type of LED</i>		SMD 3528 – SWR-C1D	SMD 3528 – SWR-C1D	SMD 3528 – SWR-C1D	SMD 3528 – SWR-C1D
Consommation <i>Consumption</i>		8 Watts	16 Watts	19 Watts	23 Watts
Nombre de LED <i>Number of LED</i>		110	216	288	348
Durée de vie <i>Lifespan</i>		50 000 h	50 000 h	50 000 h	50 000 h
Température de Couleur <i>Color temperature</i>		4100°K	4100°K	4100°K	4100°K
Flux lumineux <i>Luminous Flux</i>		544 lm ± 5%	1020 lm ± 5%	1360 lm ± 5%	1900 lm ± 5%
Température d'utilisation <i>Environment temperature</i>		-20,00°C to +50,00°C	-20,00°C to +50,00°C	-20,00°C to +50,00°C	-20,00°C to +50,00°C

Exemple de lecture de référence - *Example of decomposition Reference*

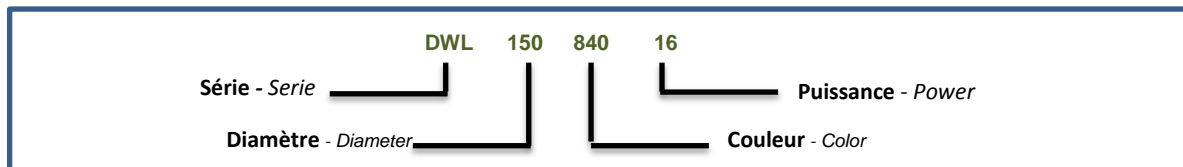

Les données et spécifications sont susceptibles de modifications sans avis préalable. *Specifications and datas are subject to change without notice.*

2010 ECOREVA Tous droits réservés. Toute reproduction partielle ou totale est formellement interdite sans le consentement écrit préalable du propriétaire des droits d'auteur. Les informations présentées dans ce document ne constituent pas et ne font pas parties d'un quelconque devis ou contrat et peuvent être modifiées sans préavis. Aucune responsabilité ne sera acceptée par l'éditeur pour toutes conséquences de leurs utilisations. Leurs publication ne confère aucun droit de licence en vertu des brevets ou autres droits de propriété industriels ou intellectuels. All right reserved. Reproduction in whole or in part is prohibited without the prior written consent of the copyright owner. The information presented in this document does not form part of any quotation or contract, is believed to be accurate and reliable and may be changed without notice. No liability will be accepted by the publisher for any consequence of its use. Publication thereof does not convey nor imply any license under patent or other industrial or intellectual property rights.

**ECOREVA SAS**

Parc Washington – 359 rue Fleming - 62400 BETHUNE – "France"  
Phone: 0033 (0) 321 571 169  
Fax: 0033 (0) 355 035 915  
E-mail: info@ecoreva.fr Website: http://www.ecoreva.com



## ➤ INSTALLATION – INSTALLATION

L'installation du produit doit être obligatoirement effectuée par du personnel dument habilité et autorisé, et dans le strict respect de la notice d'installation du produit.

*The installation of the product must be performed by a duly empowered and authorized staff, and in strict compliance with the product instruction manual for installation.*



1

Mettre hors tension  
*Turn off electricity*

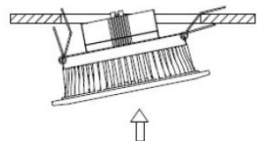

4

Insérer l'appareil dans l'emplacement.  
*Uncertainties in the camera location.*

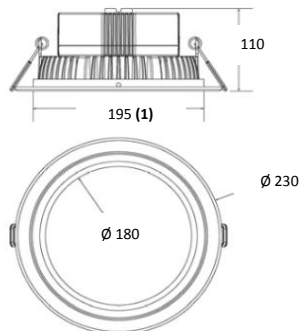

23 Watts

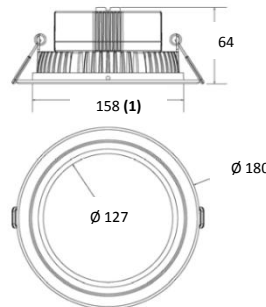

19 Watts



2

Percer le trou à la dimension indiquée ci-dessus (1)  
*Drill hole size above (1)*



5

L'appareil est en place.  
*The fixture is in place.*

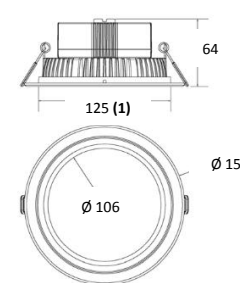

16 Watts

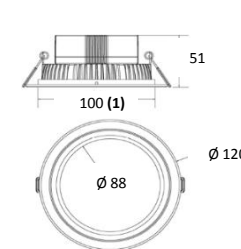

08 Watts



3

Relever les deux ressorts pour placer l'appareil.  
*Addressing the two springs to hold the device*



6

Brancher l'alimentation électrique  
*Connect the power supply*

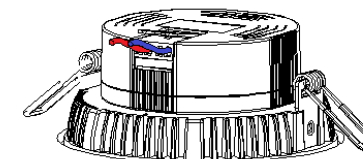

Les données et spécifications sont susceptibles de modifications sans avis préalable. *Specifications and datas are subject to change without notice.*



	DWL-120	DWL-150	DWL-180	DWL-230
<b>Poids appareil - weight unit</b>	<b>260g</b>	<b>420g</b>	<b>543g</b>	<b>1054g</b>
<b>Poids du Carton d'emballage – Weight of cardboard packaging</b>	<b>36g</b>	<b>49g</b>	<b>68g</b>	<b>80g</b>
<b>Poids du downlight avec emballage – Weight of downlight with cardboard packaging</b>	<b>296g</b>	<b>469g</b>	<b>611g</b>	<b>1134g</b>
<b>Poids du colis 20 pièces – Package Weight 20 pcs</b>	<b>5,92 kg</b>	<b>9,38 kg</b>	<b>12,50 kg</b>	<b>22,68 kg</b>
<b>Conditionnement par – Conditioning by</b>	<b>20</b>	<b>20</b>	<b>20</b>	<b>20</b>
<b>Dimension emballage 1 pièce - Packing Size 1 piece</b>	<b>130 x 130 x 70</b>	<b>160 x 160 x 60</b>	<b>195 x 195 x 70</b>	<b>240 x 240 x 115</b>

### DWL-120

#### Dimension colis – Package size

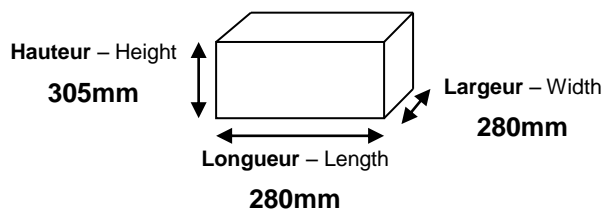

### DWL-150

#### Dimension colis – Package size

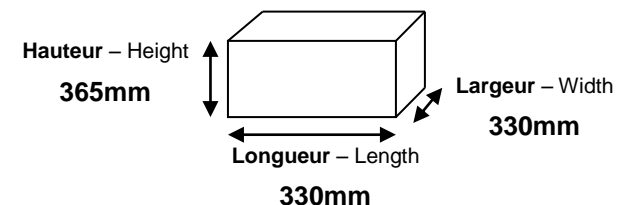

### DWL-180

#### Dimension colis – Package size

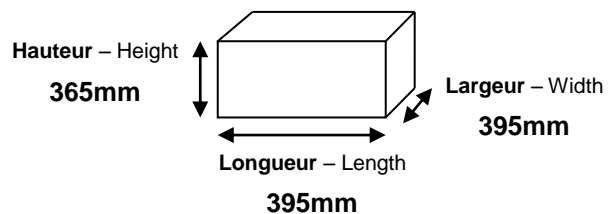

### DWL-230

#### Dimension colis – Package size

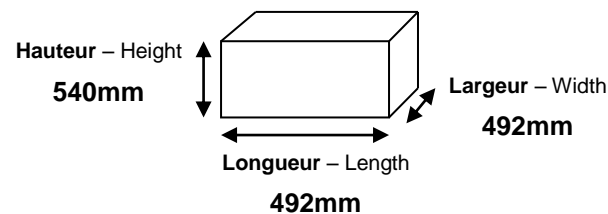

Les données et spécifications sont susceptibles de modifications sans avis préalable. *Specifications and datas are subject to change without notice.*